

MDT 109

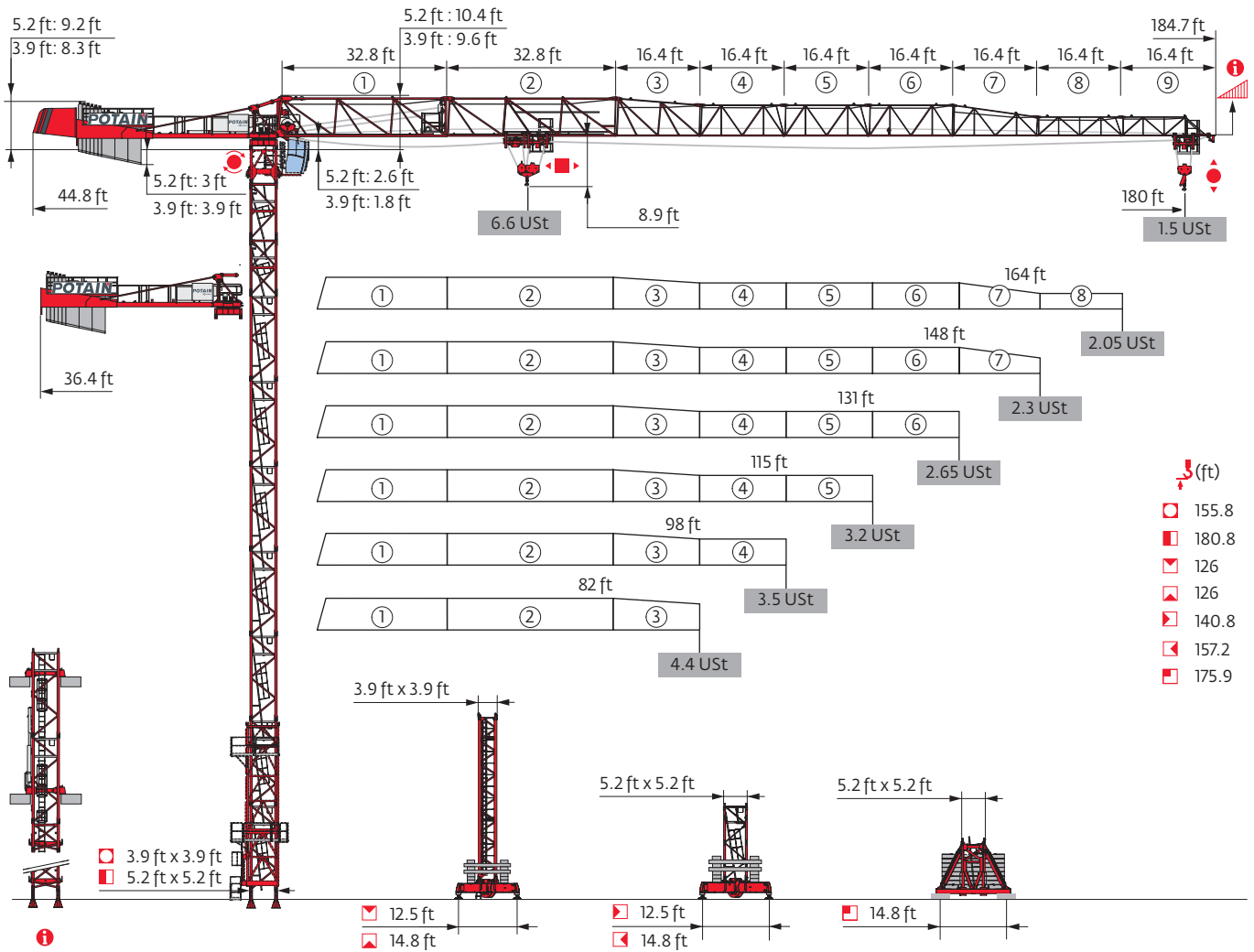

Potain Plus

Power Control

Top Site

Top Tracing 3

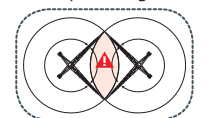
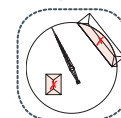
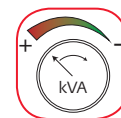

Mast - Reactions

3.9 ft City - P 12D							
Height (ft)	82	98	115	131	148	164	180
Top (ft)	131.2	131.2	131.2	131.2	121.4	121.4	121.4
Top/P+ (ft)	131.2	131.2	131.2	131.2	121.4	121.4	121.4
24.6 ft	0	0	0	0	1	1	1
34.4 ft	4	4	4	4	3	3	3
F2 (Ust)	● 106	105	103	105	101	102	103
	■ 171	171	172	175	147	147	147
F3 (Ust)	● 84	82	79	81	76	76	77
	■ 152	151	151	153	125	125	124

3.9 ft City - P 12ER							
Height (ft)	82	98	115	131	148	164	180
Top (ft)	146	155.8	155.8	155.8	155.8	146	146
Top/P+ (ft)	146	155.8	155.8	155.8	155.8	146	146
24.6 ft	2	1	1	1	1	2	2
34.4 ft	3	4	4	4	4	3	3
F2 (Ust)	● 121	130	127	131	136	126	128
	■ 217	256	250	260	260	222	221
F3 (Ust)	● 97	104	100	103	107	98	99
	■ 196	233	227	236	235	197	196

3.9 ft City - ZC 2030							
Height (ft)	82	98	115	131	148	164	180
Top (ft)	116.1	116.1	116.1	116.1	126	126	126
Top/P+ (ft)	116.1	116.1	116.1	116.1	126	126	126
24.6 ft	2	2	2	2	1	1	1
34.4 ft	2	2	2	2	3	3	3
F1 (Ust)	● 53	54	53	54	62	62	63
	■ 63	63	63	65	80	80	79

3.9 ft City - ZD 2030							
Height (ft)	82	98	115	131	148	164	180
Top (ft)	126	126	126	116.1	116.1	116.1	126
Top/P+ (ft)	126	126	126	116.1	116.1	116.1	126
24.6 ft	1	1	1	2	2	2	1
34.4 ft	3	3	3	2	2	2	3
F1 (Ust)	● 51	52	51	46	47	47	53
	■ 65	65	65	54	54	54	66

5.2 ft City - P 41A							
Height (ft)	82	98	115	131	148	164	180
Top (ft)	180.8	180.8	180.8	175.5	175.5	175.5	175.5
Top/P+ (ft)	180.8	180.8	180.8	175.5	175.5	175.5	175.5
10.9 ft	2	2	2	0	0	0	0
16.4 ft	10	10	10	11	11	11	11
F2 (Ust)	● 109	108	106	104	108	110	111
	■ 205	205	205	192	193	194	194
F3 (Ust)	● 81	79	77	74	78	78	79
	■ 180	180	179	166	166	166	165

5.2 ft City - ZC 4230							
Height (ft)	82	98	115	131	148	164	180
Top (ft)	140.8	140.8	140.8	140.8	140.8	140.8	140.8
Top/P+ (ft)	140.8	140.8	140.8	140.8	140.8	140.8	140.8
10.9 ft	1	1	1	1	1	1	1
16.4 ft	8	8	8	8	8	8	8
F1 (Ust)	● 64	64	64	65	65	65	66
	■ 83	82	82	84	84	84	83

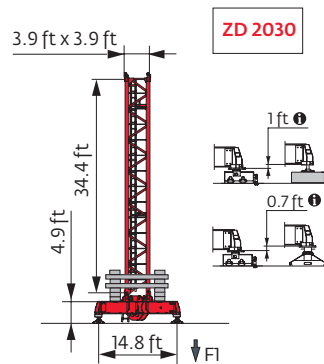
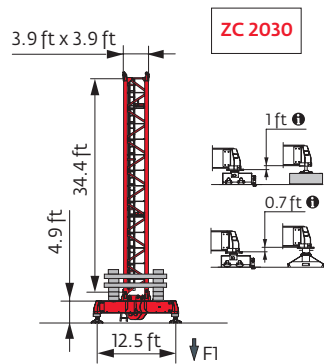
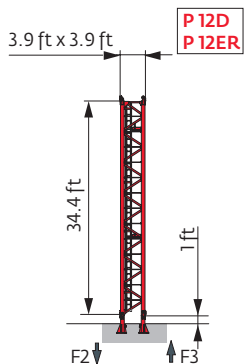



5.2 ft City - ZD 4230 - 

Span (ft)	82	98	115	131	148	164	180
r_1 (ft)	151.6	157.2	157.2	157.2	157.2	157.2	157.2
r_1/P_1 (ft)	151.6	157.2	157.2	157.2	157.2	157.2	157.2
	10.9 ft	2	1	1	1	1	1
	16.4 ft	8	9	9	9	9	9
FI (Ust)	● 61	63	63	64	65	66	65
	■ 82	87	87	88	88	88	88

5.2 ft - P 41A

Span (ft)	82	98	115	131	148	164	180
r_1 (ft)	176.5	176.5	176.5	170.9	170.9	170.9	170.9
r_1/P_1 (ft)	176.5	176.5	176.5	170.9	170.9	170.9	170.9
	6.6 ft	1	1	1	1	1	1
	10.9 ft	1	1	1	2	2	2
	16.4 ft	10	10	10	9	9	9
F2 (Ust)	● 110	109	107	107	111	112	114
	■ 208	209	209	202	203	203	203
F3 (Ust)	● 79	77	75	73	77	77	78
	■ 180	180	180	172	172	172	171

5.2 ft - S 41A - 

Span (ft)	82	98	115	131	148	164	180
r_1 (ft)	170.6	175.9	175.9	175.9	175.9	175.9	175.9
r_1/P_1 (ft)	170.6	175.9	175.9	175.9	175.9	175.9	175.9
	6.6 ft	1	1	1	1	1	1
	10.9 ft	1	0	0	0	0	0
	16.4 ft	9	10	10	10	10	10
FI (Ust)	● 75	78	78	79	80	81	82
	■ 109	115	115	116	116	116	116

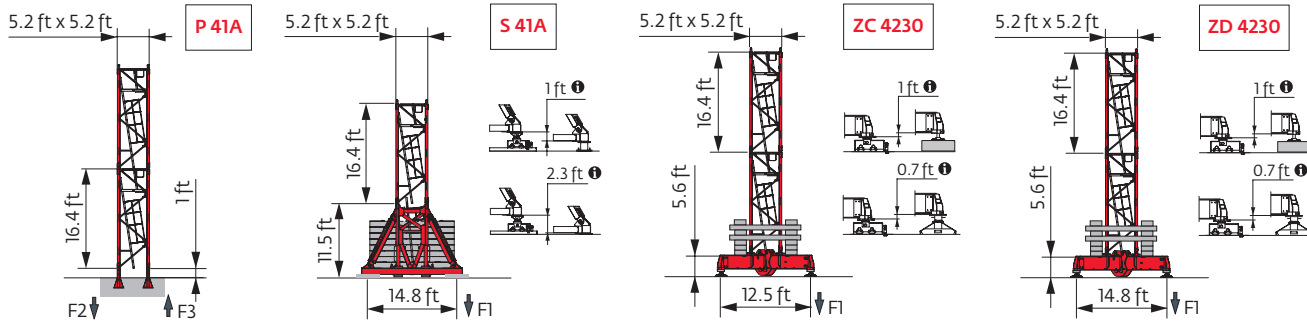

Note: When "ASCE" is noted in this data sheet it is referring to 115 mph Wind Zone, Exposure B, Design Wind Speed = 98 mph. See back cover for design wind speed calculations.

 Motorized accesses: adapted mast compositions, base ballast and reactions.

Anchorage



Base ballast

(Ust) / 3.9 ft City - ZC 2030 -

AVAIL (ft)	82	98	115	131	148	164	180
126					82.7	82.7	82.7
116.1	66.1	66.1	66.1	66.1	66.1	71.7	71.7
81.7	49.6	49.6	49.6	49.6	49.6	49.6	49.6
47.3	49.6	49.6	49.6	49.6	49.6	49.6	49.6

(Ust) / 3.9 ft City - ZD 2030 -

AVAIL (ft)	82	98	115	131	148	164	180
126	66.1	66.1	66.1				60.6
116.1	49.6	49.6	49.6	49.6	49.6	49.6	49.6
81.7	49.6	49.6	49.6	49.6	49.6	49.6	49.6
47.3	49.6	49.6	49.6	49.6	49.6	49.6	49.6

(Ust) / 5.2 ft City - ZC 4230 -

AVAIL (ft)	82	98	115	131	148	164	180
140.8	88.2	88.2	88.2	88.2	82.7	82.7	82.7
124.3	60.6	60.6	55.1	60.6	66.1	66.1	66.1
107.9	49.6	49.6	49.6	49.6	49.6	49.6	55.1
91.5	49.6	49.6	49.6	49.6	49.6	49.6	49.6
75.1	49.6	49.6	49.6	49.6	49.6	49.6	49.6
58.7	49.6	49.6	49.6	49.6	49.6	49.6	49.6
42.3	49.6	49.6	49.6	49.6	49.6	49.6	49.6

(Ust) / 5.2 ft City - ZD 4230 -

AVAIL (ft)	82	98	115	131	148	164	180
157.2		88.2	88.2	88.2	88.2	88.2	82.7
151.6	82.7	82.7	82.7	82.7	82.7	77.2	77.2
135.2	60.6	55.1	55.1	55.1	55.1	55.1	55.1
118.8	49.6	49.6	49.6	49.6	49.6	49.6	49.6
102.4	49.6	49.6	49.6	49.6	49.6	49.6	49.6
86	49.6	49.6	49.6	49.6	49.6	49.6	49.6
69.6	49.6	49.6	49.6	49.6	49.6	49.6	49.6
53.2	49.6	49.6	49.6	49.6	49.6	49.6	49.6
36.8	49.6	49.6	49.6	49.6	49.6	49.6	49.6

(Ust) / 5.2 ft - S 41A -

AVAIL (ft)	82	98	115	131	148	164	180
175.9		125.7	125.7	125.7	125.7	125.7	125.7
170.6	119.1	119.1	119.1	119.1	119.1	119.1	112.4
154.2	92.6	92.6	92.6	92.6	86	86	86
137.8	66.1	66.1	66.1	66.1	59.5	59.5	59.5
121.4	46.3	46.3	46.3	46.3	46.3	46.3	46.3
105	46.3	46.3	46.3	46.3	46.3	46.3	46.3
88.6	46.3	46.3	46.3	46.3	46.3	46.3	46.3
72.2	46.3	46.3	46.3	46.3	46.3	46.3	46.3
55.8	46.3	46.3	46.3	46.3	46.3	46.3	46.3
39.4	46.3	46.3	46.3	46.3	46.3	46.3	46.3

Load curves



(ft)			49	56	66	72	82	89	98	105	115	121	131	138	148	154	164	171	180	ft	
	6.6 USt	3.3 USt																			
180	9 → 54	97 - 108	6.6	6.3	5.3	4.7	4.1	3.7	3.3	3.3	3.1	2.9	2.65	2.5	2.2	2.05	1.8	1.6	1.4	USt	
	9 → 54	97 - 108	6.6	6.3	5.3	4.7	4.1	3.7	3.3	3.3	3.1	2.9	2.65	2.5	2.3	2.1	1.85	1.7	1.5	USt P+	
164	9 → 53	97 - 108	6.6	6.3	5.3	4.7	4	3.7	3.3	3.3	3.1	2.9	2.65	2.5	2.3	2.2	2.05	USt			
	9 → 53	97 - 108	6.6	6.3	5.3	4.7	4	3.7	3.3	3.3	3.1	2.9	2.65	2.5	2.3	2.2	2.05	USt P+			
148	9 → 54	97 - 108	6.6	6.3	5.3	4.7	4.1	3.7	3.3	3.3	3.1	2.9	2.65	2.5	2.3	USt					
	9 → 54	97 - 108	6.6	6.3	5.3	4.7	4.1	3.7	3.3	3.3	3.1	2.9	2.65	2.5	2.3	USt P+					
131	9 → 54	97 - 108	6.6	6.4	5.3	4.7	4	3.7	3.3	3.3	3.1	2.9	2.65	USt							
	9 → 54	97 - 108	6.6	6.4	5.3	4.7	4	3.7	3.3	3.3	3.1	2.9	2.65	USt P+							
115	9 → 55	99 - 110	6.6	6.4	5.4	4.8	4.2	3.8	3.3	3.3	3.2	USt									
	9 → 55	99 - 110	6.6	6.4	5.4	4.8	4.2	3.8	3.3	3.3	3.2	USt P+									
98	9 → 57		6.6	6.6	5.6	4.9	4.2	3.8	3.3	USt											
	9 → 57		6.6	6.6	5.6	4.9	4.2	3.8	3.3	USt P+											
82	9 → 57		6.6	6.6	5.6	4.9	4.2	USt													
	9 → 57		6.6	6.6	5.6	4.9	4.2	USt P+													

$W = W - 0.43 \text{ USt max.}$



(ft)			49	56	66	72	82	89	98	105	115	121	131	138	148	154	164	171	180	ft	
	6.6 USt	3.3 USt																			
180	7 → 55	103 - 105	6.6	6.5	5.5	4.9	4.3	3.9	3.5	3.3	2.95	2.75	2.5	2.35	2.1	1.9	1.65	1.45	1.3	USt	
	7 → 55	103 - 105	6.6	6.5	5.5	4.9	4.3	3.9	3.5	3.3	2.95	2.75	2.5	2.35	2.15	1.95	1.75	1.55	1.35	USt P+	
164	7 → 55	102 - 104	6.6	6.5	5.5	4.9	4.3	3.9	3.4	3.3	2.95	2.75	2.5	2.35	2.15	2.05	1.9	USt			
	7 → 55	102 - 104	6.6	6.5	5.5	4.9	4.3	3.9	3.4	3.3	2.95	2.75	2.5	2.35	2.15	2.05	1.9	USt P+			
148	7 → 55	102 - 104	6.6	6.5	5.5	4.9	4.3	3.9	3.5	3.3	2.95	2.75	2.5	2.35	2.15	USt					
	7 → 55	102 - 104	6.6	6.5	5.5	4.9	4.3	3.9	3.5	3.3	2.95	2.75	2.5	2.35	2.15	USt P+					
131	7 → 56	102 - 104	6.6	6.6	5.5	4.9	4.3	3.9	3.5	3.3	2.95	2.75	2.5	USt							
	7 → 56	102 - 104	6.6	6.6	5.5	4.9	4.3	3.9	3.5	3.3	2.95	2.75	2.5	USt P+							
115	7 → 57	105 - 106	6.6	6.6	5.6	5.1	4.4	4	3.6	3.3	3	USt									
	7 → 57	105 - 106	6.6	6.6	5.6	5	4.4	4	3.6	3.3	3	USt P+									
98	7 → 58		6.6	6.6	5.8	5.1	4.4	4	3.5	USt											
	7 → 58		6.6	6.6	5.8	5.1	4.4	4	3.5	USt P+											
82	7 → 58		6.6	6.6	5.8	5.1	4.4	USt													
	7 → 58		6.6	6.6	5.8	5.1	4.4	USt P+													

$W = W - 0.09 \text{ USt max.}$

Jib weight & counter-jib ballast

(ft)	(lb) - 25 LVF (+/- 5%)					(lb)
				7,937 lb	2,425 lb	
180 ft	16,887	16,623	17,269	3	6	38,360
164 ft	16,455	16,191	16,837	3	5	35,935
148 ft	15,937	15,673	16,319	3	4	33,510
131 ft	15,280	15,016	15,662	3	3	31,085
115 ft	14,520	14,255	14,901	3	2	28,660
98 ft	13,958	13,693	14,339	3	1	26,235
82 ft	13,327	13,062	13,708	3	0	23,810

CAU - 7,937 lb



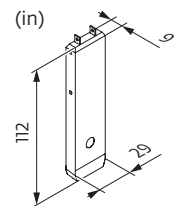
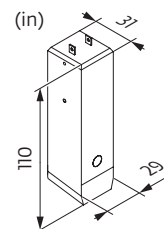









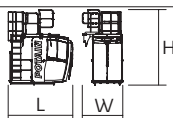

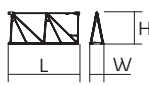
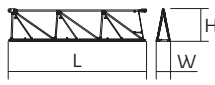

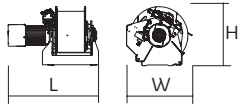
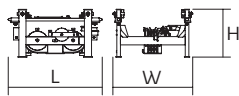
CAV - 2,425 lb

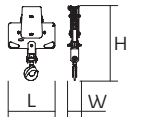

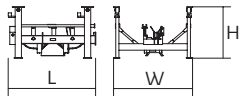

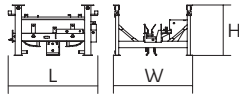

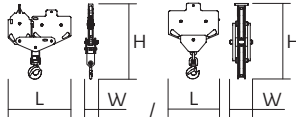

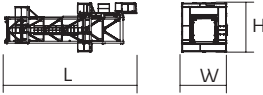

Dimensions and weight

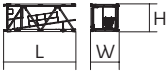
Slewing crane part:  180 ft -  -  -  25 LVF

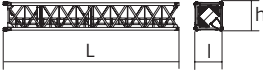

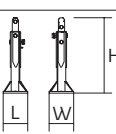
Slewing crane part		L (ft)	W (ft)	H (ft)	lb (+/- 5%)	
Counter-jib		 3.9 ft	39.2	6.8	8.1	12,302
		 5.2 ft	39.2	7.1	8.9	12,633
Towerhead + cab		Ultra View	10.4	6.5	11.9	2,194
Jib section		① 25 LVF 6 DVF	34.8	8.8	8.6	7,253
Jib section		④	17	3.4	6.3	886
		⑤	17	3.4	6.3	756
		⑥	17	3.4	6.2	756
		⑧	16.9	3.4	3.9	503
Jib section		②	33.5	3.4	7.7	3,025
Jib section		③	17	3.4	7.6	992
		⑦	16.9	3.4	6.2	646
Jib section		⑨	16.7	3.4	3.8	417
Hoisting winch (+ rope)		25 LVF	4.4	2.3	2.3	1,687
		33 LVF	4.5	3	2.9	2,116
Trolley		 6.6 Ust	5.2	4.4	2.9	617
Pulley block		 6.6 Ust	3	0.9	4.3	628
Trolley		 6.6 Ust	4.6	4.1	3.1	617
Trolley		 6.6 Ust	4.7	4.1	3.1	617
		 3.3 Ust	5	4.3	3.1	518
Pulley block		 6.6 Ust	4.1	0.9	5	551
		 3.3 Ust	2.6	0.7	4.2	287

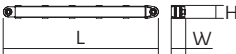
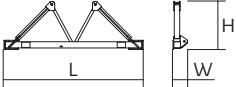
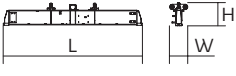
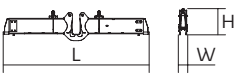
Crane tower		L (ft)	W (ft)	H (ft)	lb (+/- 5%)	
Telescopic cage T 41		5.2 ft	35.6	12.3	13.5	15,653
K40/K40		5.2 ft	7.3	6.9	6.8	3,208
K 447E KM 447E KM 449E		5.2 ft	33.5 33.5 33.5	5.3 5.3 5.3	5.3 5.3 5.3	7,474 7,088 8,448
K 447A KMT 447A K 449A KMT 449A		5.2 ft	17.1 17.1 17.1 17.1	5.5 5.5 5.5 5.5	5.3 5.3 5.3 5.3	4,079 3,847 4,916 4,696
K 447C		5.2 ft	11.3	5.5	5.3	2,998
S 28ES-2 SR 26E-2 SR 28ER-2		3.9 ft	35.3 35.3 35.3	4.2 4.2 4.2	4.2 4.2 4.2	7,604 6,735 8,867
SR 25F-2		3.9 ft	25.4	4.2	4.2	4,447
SR 26X-2		3.9 ft	10.7	4.1	4.1	2,169
K40/L20-2		5.2/3.9 ft	9.7	6.8	6.9	4,630
Fixing angles		P 12D P 12ER P 41A	1.6 2.6 1.2	1.6 2.6 1.2	3.7 4.3 3.7	357 1,102 293
Basic mast unit		S 41A	11.9	6.4	6.8	6,537
Struts		S 41A	10.4	0.9	0.8	489
Half-bearer		S 41A	16.7	2	5.8	2,524
Cross girder		ZC 2030 ZD 2030 ZC 4230 ZD 4230	18.5 21.7 18.5 21.8	2.7 2.7 2.7 2.7	3.8 3.8 3.4 3.4	3,307 3,726 3,505 4,035
Cross girder		ZC 2030 ZD 2030 ZC 4230 ZD 4230	18.5 21.7 18.5 21.8	1.5 1.5 1.5 1.5	4.8 4.8 4.4 4.4	3,825 4,255 4,178 4,707

Mechanisms

480 V - 60 Hz											hp	kW	
	25 LVF 15 Optima	fpm	97	128	179	230	49	66	92	115	25	18	912 ft
		USt	3.3	2.5	1.7	0.8	6.6	5	3.3	1.8			
	33 LVF 15 Optima	fpm	118	154	221	315	59	79	116	157	33	22	1,001 ft
		USt	3.3	2.5	1.7	0.6	6.6	5	3.3	1.4			
	6 DVF 4 Optima	fpm	0 → 262 (6.6 USt) 0 → 328 (2.2 USt)								5.5	4	
	RVF 152 Optima+	rpm	0 → 0,8								2 x 5.5	2 x 4	

480 V (+6% -10%) 60 Hz	25 LVF: 34 → 24 kVA 33 LVF: 41 → 28 kVA	

25 LVF 15 Optima

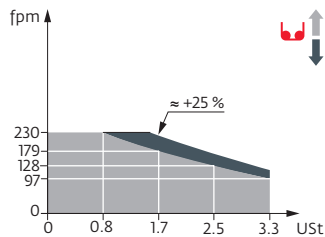

33 LVF 15 Optima

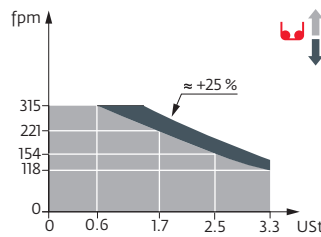

These mast combinations meet the EN 14439 and ASME B30.3-2016 specifications for "out of service" wind conditions, provided the illustrated wind speed matches required design wind speed for the location of the tower crane. The "out of service" design wind speed was determined in accordance with ASCE 7-10, Figure 26.5-1A. The wind velocity, used for this configuration was 98 mph (158 kph), which represents a nominal design 3-second wind gust at 33 ft (10 m) above ground for Exposure B category. A factor of 0.85 was applied to the 700-year ultimate design wind speed of 115 mph (185 kph), per ASCE 37-02, with the assumption that this crane is considered a temporary structure used during a construction period of 2 years or less.

- Jib elevation
- Standard equipment
- Options
- Potain Plus function: Plus load curves
- Hook heights with Plus load curves
- Reactions in service
- Reactions out of service
- Total ballast weight
- Jib weight
- Lorry 44 ft
- Container High Cube 40 ft, and/or Flat Rack 20 ft
- Hoisting
- Trolleying
- Slewing
- Travelling
- Required power
- Power Control Function: winch speeds adapted to the available power
- Consult us

This commercial document is not legally binding. For any technical information, please refer to the corresponding instructions.

