

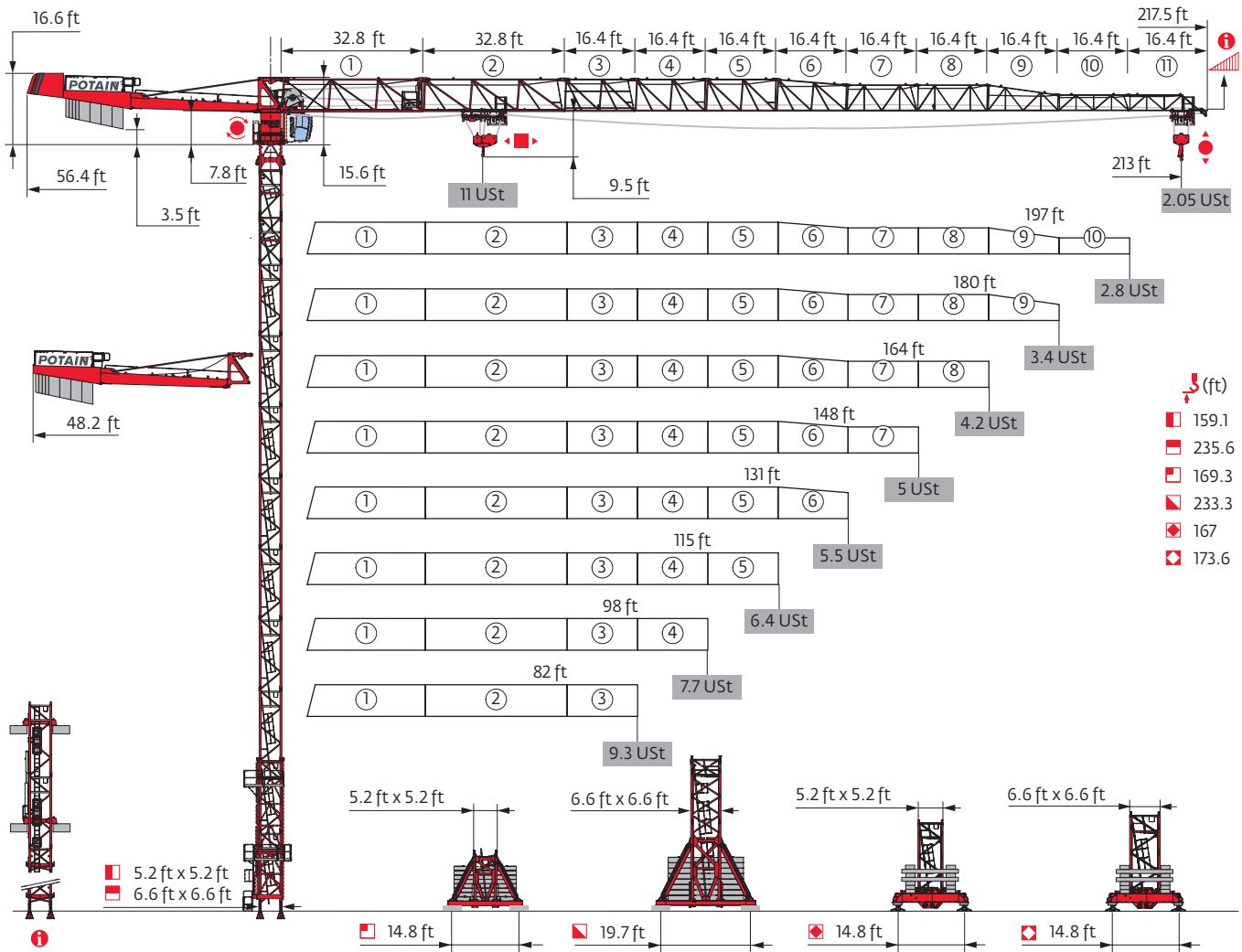

# MDT 219 J10







Potain Plus Power Control



Top Site Top Tracing 3

Mast - Reactions



**5.2 ft City - ZD 4230 - **

MAVAIL (ft)	82	98	115	131	148	164	180	197	213
 (ft)	150.6	150.6	155.8	150.6	150.6	150.6	145	145	145
 /P <sub>+</sub> (ft)	150.6	150.6	155.8	150.6	150.6	150.6	145	145	145
	10.9 ft	0	0	2	0	0	0	1	1
	16.4 ft	9	9	8	9	9	9	8	8
F1 (Ust)	● 78	79	81	79	81	82	82	83	84
	■ 71	71	77	72	75	76	75	78	81



**5.2 ft City - ZD 463 - **

MAVAIL (ft)	82	98	115	131	148	164	180	197	213
 (ft)	167	167	167	161.4	161.4	155.8	150.6	155.8	155.8
 /P <sub>+</sub> (ft)	167	167	167	161.4	161.4	155.8	150.6	155.8	155.8
	10.9 ft	0	0	1	1	2	0	2	2
	16.4 ft	10	10	10	9	9	9	8	8
F1 (Ust)	● 85	86	86	85	87	85	85	89	90
	■ 84	84	85	82	85	82	80	88	93



**5.2 ft - P 41A**

MAVAIL (ft)	82	98	115	131	148	164	180	197	213
 (ft)	159.1	159.1	159.1	153.5	153.5	148	148	148	148
 /P <sub>+</sub> (ft)	159.1	159.1	159.1	153.5	153.5	148	148	148	148
	6.6 ft	1	1	1	1	1	1	1	1
	10.9 ft	2	2	2	0	0	1	1	1
	16.4 ft	8	8	8	9	9	8	8	8
F2 (Ust)	● 138	139	140	138	140	138	142	144	146
	■ 159	158	161	150	152	146	153	161	168
F3 (Ust)	● 104	103	103	101	102	100	104	105	107
	■ 130	128	130	118	120	113	120	127	135



**5.2 ft - S 41A - **

MAVAIL (ft)	82	98	115	131	148	164	180	197	213
 (ft)	169.3	164	164	164	158.5	158.5	152.9	152.9	152.9
 /P <sub>+</sub> (ft)	169.3	164	164	164	158.5	158.5	152.9	152.9	152.9
	6.6 ft	1	1	1	1	1	1	1	1
	10.9 ft	2	0	0	0	1	2	2	2
	16.4 ft	8	9	9	9	8	8	7	7
F1 (Ust)	● 90	87	88	89	89	90	90	90	91
	■ 100	90	92	93	89	90	90	94	99

**5.2 ft - ZD 4230 - **

MAVAIL (ft)	82	98	115	131	148	164	180	197	213
 (ft)	146	146	146	146	146	146	140.8	140.8	140.8
 /P <sub>+</sub> (ft)	146	146	146	146	146	146	140.8	140.8	140.8
	6.6 ft	1	1	1	1	1	1	1	1
	10.9 ft	2	2	2	2	2	0	0	0
	16.4 ft	7	7	7	7	7	8	8	8
F1 (Ust)	● 79	80	81	81	82	83	83	83	84
	■ 75	75	76	77	78	79	77	80	84

**5.2 ft - ZD 463 - **

MAVAIL (ft)	82	98	115	131	148	164	180	197	213
 (ft)	162.4	162.4	157.2	157.2	157.2	151.6	146	146	146
 /P <sub>+</sub> (ft)	162.4	162.4	157.2	157.2	157.2	151.6	146	146	146
	6.6 ft	1	1	1	1	1	1	1	1
	10.9 ft	2	2	0	0	0	1	2	2
	16.4 ft	8	8	9	9	9	8	7	7
F1 (Ust)	● 87	88	84	86	87	85	86	86	87
	■ 92	91	84	86	87	84	83	87	92

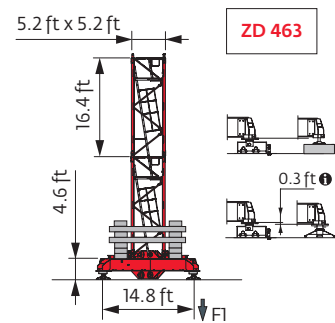
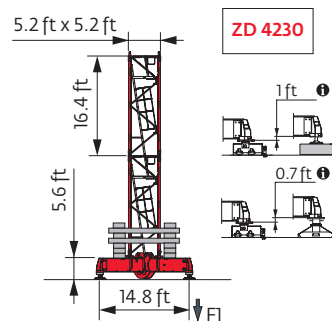
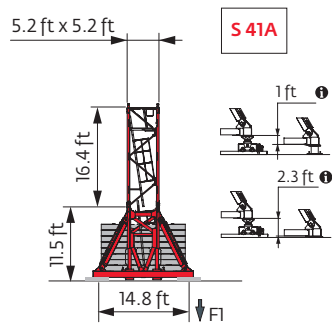
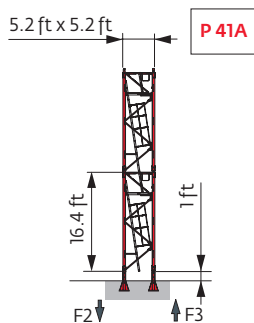



**i** Motorized accesses : adapted mast compositions, base ballast and reactions.

**6.6 ft - P 602B**

Height (ft)	82	98	115	131	148	164	180	197	213	
Height (ft)	235.6	235.6	235.6	230	230	230	230	224.7	219.2	
Height/P <sub>r</sub> (ft)	235.6	235.6	235.6	230	230	230	230	224.7	219.2	
	6.6 ft	1	1	1	1	1	1	1	1	
	10.9 ft	0	0	0	1	1	1	2	0	
	16.4 ft	14	14	14	13	13	13	13	12	
F2 (Ust)	●	175	176	176	175	177	179	184	182	178
	■	336	335	338	327	330	332	338	331	320
F3 (Ust)	●	130	130	129	128	129	130	135	133	129
	■	296	295	297	285	287	288	293	287	277

**6.6 ft - V 60A - **

Height (ft)	82	98	115	131	148	164	180	197	213
Height (ft)	211.3	211.3	211.3	211.3	211.3	211.3	206	206	200.5
Height/P <sub>r</sub> (ft)	211.3	211.3	211.3	211.3	211.3	211.3	206	206	200.5
	6.6 ft	1	1	1	1	1	1	1	1
	10.9 ft	1	1	1	1	1	2	2	0
	16.4 ft	11	11	11	11	11	10	10	11
F1 (Ust)	●	102	102	103	104	105	106	106	105
	■	144	144	145	146	147	148	145	149

**6.6 ft - V 63A - **

Height (ft)	82	98	115	131	148	164	180	197	213
Height (ft)	233.3	233.3	233.3	233.3	233.3	233.3	233.3	228	228
Height/P <sub>r</sub> (ft)	233.3	233.3	233.3	233.3	233.3	233.3	233.3	228	228
	6.6 ft	1	1	1	1	1	1	1	1
	10.9 ft	0	0	0	0	0	0	1	1
	16.4 ft	12	12	12	12	12	12	11	11
F1 (Ust)	●	122	122	123	124	125	126	127	127
	■	179	178	180	181	182	183	186	187

**6.6 ft - ZD 463 - **

Height (ft)	82	98	115	131	148	164	180	197	213
Height (ft)	173.6	173.6	173.6	173.6	173.6	173.6	168	162.4	162.4
Height/P <sub>r</sub> (ft)	173.6	173.6	173.6	173.6	173.6	173.6	168	162.4	162.4
	6.6 ft	1	1	1	1	1	1	1	1
	10.9 ft	0	0	0	0	0	0	1	2
	16.4 ft	10	10	10	10	10	10	9	8
F1 (Ust)	●	103	102	102	103	104	105	104	105
	■	132	130	132	133	135	136	132	135

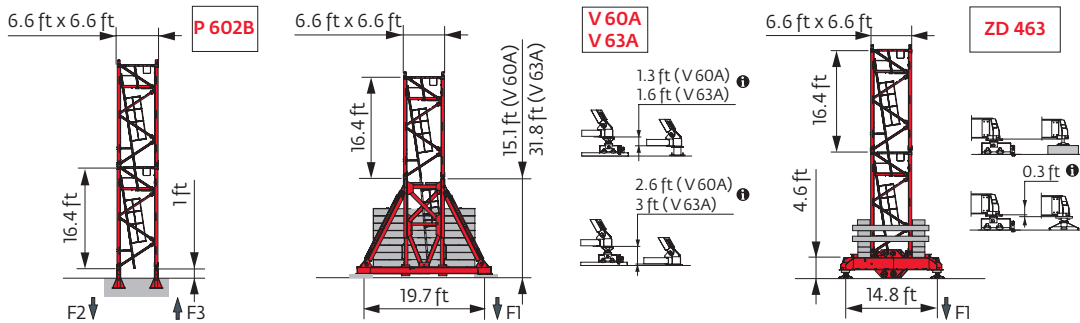

Note: When "ASCE" is noted in this data sheet it is referring to 115 mph Wind Zone, Exposure B, Design Wind Speed = 98 mph. See back cover for design wind speed calculations.

Anchorage





Load curves



▲▲▲▲▲ (ft)			56	66	72	82	89	98	105	115	121	131	138	148	154	164	171	180	187	197	203	213	ft
▲▲▲▲▲	USt	5.5 USt																					
213	10 → 53	98 - 107	10.5	8.8	7.9	6.8	6.2	5.5	5.5	5.1	4.7	4.4	4.1	3.8	3.6	3.3	3.1	2.85	2.65	2.4	2.15	2.05	USt
	10 → 58	106 - 115	11	9.7	8.7	7.5	6.9	6	5.6	5.5	5.1	4.6	4.3	4	3.7	3.5	3.3	3	2.8	2.5	2.3	2.05	USt P+
197	10 → 57	106 - 115	11	9.5	8.6	7.4	6.8	6	5.5	5.5	5.1	4.6	4.3	3.9	3.7	3.4	3.3	3.1	2.95	2.75			USt
	10 → 62	108 - 115	11	10.3	9.2	8	7.2	6.3	5.7	5.5	5.1	4.7	4.4	4	3.8	3.5	3.3	3.1	2.95	2.8			USt P+
180	10 → 62	115 - 122	11	10.4	9.4	8.2	7.5	6.6	6.2	5.5	5.5	5.1	4.7	4.3	4.1	3.8	3.7	3.4					USt
	10 → 65	117 - 122	11	11	9.9	8.6	7.9	6.9	6.3	5.6	5.5	5.1	4.8	4.4	4.2	3.9	3.7	3.4					USt P+
164	10 → 66	123 - 131	11	11	10	8.7	8	7.1	6.6	6	5.6	5.5	5.1	4.7	4.4	4.1							USt
	10 → 68	123 - 131	11	11	10.4	9	8.3	7.4	6.8	6.1	5.6	5.5	5.2	4.8	4.5	4.2							USt P+
148	10 → 67	124 - 133	11	11	10.1	8.8	8.1	7.2	6.7	6	5.7	5.5	5.3	4.9									USt
	10 → 69	128 - 135	11	11	10.5	9.1	8.3	7.4	6.9	6.2	5.8	5.5	5.4	5									USt P+
131	10 → 68	126 - 131	11	11	10.3	9	8.3	7.3	6.8	6.2	5.8	5.5											USt
	10 → 69	129 - 131	11	11	10.6	9.2	8.4	7.5	7	6.3	5.9	5.5											USt P+
115	10 → 69		11	11	10.5	9.1	8.4	7.5	6.9	6.3													USt
	10 → 70		11	11	10.7	9.3	8.5	7.6	7	6.4													USt P+
98	10 → 70		11	11	10.7	9.3	8.6	7.6															USt
	10 → 71		11	11	10.8	9.4	8.6	7.7															USt P+
82	10 → 69		11	11	10.6	9.2																	USt
	10 → 70		11	11	10.6	9.2																	USt P+

$W_{10} = W_{10} - 0.53 \text{ USt max.}$



▲▲▲▲▲ (ft)			56	66	72	82	89	98	105	115	121	131	138	148	154	164	171	180	187	197	203	213	ft
▲▲▲▲▲	USt	5.5 USt																					
213	8 → 53	100 - 103	10.6	8.9	8	7	6.4	5.6	5.4	4.8	4.5	4.1	3.9	3.6	3.4	3.1	2.95	2.65	2.45	2.2	1.95	1.8	USt
	8 → 58	107 - 110	11	9.8	8.8	7.6	7	6.1	5.7	5.2	4.8	4.4	4.1	3.8	3.5	3.3	3.1	2.8	2.6	2.3	2.1	1.85	USt P+
197	8 → 58	108 - 110	11	9.7	8.7	7.6	6.9	6.1	5.7	5.3	4.9	4.5	4.2	3.9	3.7	3.4	3.2	2.9	2.7	2.55			USt
	8 → 62	114 - 116	11	10.4	9.3	8.1	7.4	6.6	6.1	5.5	5.2	4.8	4.4	4.1	3.8	3.5	3.3	3.1	2.85	2.6			USt P+
180	8 → 63	118 - 120	11	10.5	9.5	8.3	7.6	6.7	6.3	5.7	5.4	5	4.7	4.3	4	3.7	3.5	3.3					USt
	8 → 66	121 - 123	11	11	10	8.7	8	7.1	6.6	5.9	5.5	5.1	4.8	4.4	4.1	3.8	3.6	3.4					USt P+
164	8 → 67	124 - 126	11	11	10.1	8.8	8.1	7.2	6.7	6.1	5.7	5.3	4.9	4.5	4.2	3.9							USt
	8 → 69	125 - 128	11	11	10.5	9.1	8.4	7.4	6.9	6.2	5.7	5.3	5	4.6	4.3	4							USt P+
148	8 → 67	126 - 129	11	11	10.2	8.9	8.2	7.3	6.8	6.1	5.8	5.4	5.1	4.7									USt
	8 → 69	129 - 132	11	11	10.5	9.2	8.4	7.5	7	6.3	5.9	5.5	5.2	4.8									USt P+
131	8 → 69	128 - 131	11	11	10.4	9.1	8.4	7.4	6.9	6.3	5.9	5.5											USt
	8 → 70	131 - 131	11	11	10.6	9.3	8.5	7.6	7	6.4	6	5.5											USt P+
115	8 → 70		11	11	10.6	9.2	8.5	7.6	7	6.4													USt
	8 → 71		11	11	10.7	9.3	8.6	7.6	7.1	6.4													USt P+
98	8 → 71		11	11	10.8	9.4	8.7	7.7															USt
	8 → 71		11	11	10.9	9.5	8.7	7.7															USt P+
82	8 → 70		11	11	10.7	9.3																	USt
	8 → 70		11	11	10.7	9.3																	USt P+

$W_{10} = W_{10} - 0.18 \text{ USt max.}$

Jib weight & counter-jib ballast

▲▲▲▲▲	▲▲▲▲▲ (lb) - 50 LVF (+/- 5%)			■ ■ ■ ■ ■		▲ (lb)
	USt	USt	USt	7,937 lb	2,425 lb	
213 ft	24,403	23,940	24,590	4	4	41,447
197 ft	23,962	23,499	24,149	4	4	41,447
180 ft	23,257	22,860	23,455	4	4	41,447
164 ft	22,595	22,198	22,794	4	4	41,447
148 ft	21,821	21,425	22,020	4	3	39,022
131 ft	20,962	20,565	21,160	4	2	36,597
115 ft	19,903	19,507	20,102	4	1	34,172
98 ft	18,797	18,400	18,995	4	0	31,747
82 ft	17,690	17,293	17,888	3	2	28,660

CAU - 7,937 lb



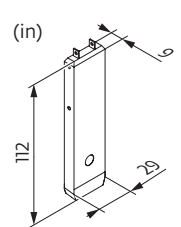
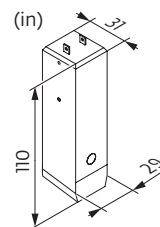



CAV - 2,425 lb







Dimensions and weight

Slewing crane part:  213 ft -  -  50 LVF

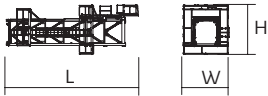

Slewing crane part		L (ft)	W (ft)	H (ft)	lb (+/- 5%)	
Counter-jib		36.7	5	8.3	13,096	
Towerhead + cab		Ultra View 5.2 ft 6.6 ft	15.4 15.6	7.5 7.5	8.2 8.2	14,749 16,513
Jib section		35.8	9.6	8.6	9,943	
Jib section		33.7	3.4	7.9	4,156	
Jib section		③ ④ ⑤ ⑦ ⑧ ⑩	17.2 17 17 17 17 16.9	3.4 3.4 3.4 3.4 3.4 3.4	7.7 7.6 7.6 6.3 6.2 3.9	1,654 1,327 1,327 860 774 529
Jib section		⑥ ⑨	17 16.9	3.4 3.4	7.6 6.2	1,058 661
Jib section		⑪	16.7	3.4	3.8	441
Hoisting winch (+ rope)		50 LVF 50 LVF GH	5 5.3	3 4.2	2.8 3.9	2,646 4,101
Trolley		 11 USt	5.9	4.4	3.2	362
Pulley block		 11 USt	3.3	1.4	6.6	441
Trolley		 11 USt	5.4	4.3	3	362
Trolley		 11 USt  5.5 USt	5.2 5.2	4.3 4.2	3 3	353 507
Pulley block		 11 USt  5.5 USt	5.4 3.6	0.8 0.5	5.6 4.9	675 695

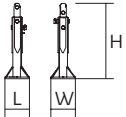
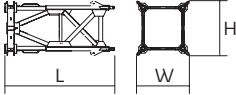
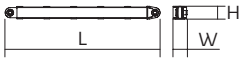
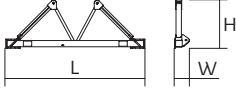
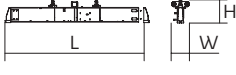
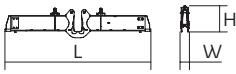
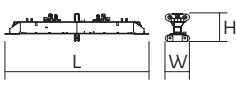
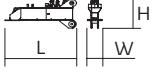
Crane tower			L (ft)	W (ft)	H (ft)	lb (+/- 5%)
Telescopic cage T41 Telescopic cage T61		□ 5.2 ft □ 6.6 ft	35.6 35.5	12.3 13.6	13.5 14.7	15,653 21,385
K40/K40-2 K60/K60-2		□ 5.2 ft □ 6.6 ft	7.3 7.3	6.9 8.2	6.8 8.1	2,932 4,255
K 447E KM 447E KM 449E K 649B KM 649E		□ 5.2 ft □ 5.2 ft □ 5.2 ft □ 6.6 ft □ 6.6 ft	33.5 33.5 33.5 33.6 33.8	5.3 5.3 5.3 6.8 6.7	5.3 5.3 5.3 6.7 6.7	7,474 7,088 8,448 11,663 10,692
K 447A KMT 447A K 449A KMT 449A KR 649A KRMT 649A K 649A KMT 649A		□ 5.2 ft □ 5.2 ft □ 5.2 ft □ 5.2 ft □ 6.6 ft □ 6.6 ft □ 6.6 ft □ 6.6 ft	17.1 17.1 17.1 17.1 17.2 17.2 17.2 17.2	5.5 5.5 5.5 5.5 6.9 6.9 6.8 6.8	5.3 5.3 5.3 5.3 6.8 6.8 6.7 6.7	4,079 3,847 4,916 4,696 7,165 6,724 6,184 5,666
K 447C K 649C KMT 649C KRMT 649C		□ 5.2 ft □ 6.6 ft □ 6.6 ft □ 6.6 ft	11.3 11.7 11.7 11.7	5.5 6.8 6.8 6.9	5.3 6.7 6.7 6.8	2,998 4,376 4,542 5,401
Fixing angles		P 41A P 602B	1.2 2.1	1.2 2.1	3.7 4.2	293 650
Basic mast unit		S 41A V 60A V 63A	11.9 16.4 32.9	6.4 7.9 7.9	6.8 7.9 7.9	6,537 9,674 16,502
Struts		S 41A V 60A V 63A	10.4 14.8 14.8	0.9 1 1.1	0.8 1 1.1	489 919 1,135
Half-bearer		S 41A V 60A V 63A	16.7 22 22	2 2.3 2.3	5.8 7.6 7.6	2,524 3,519 4,079
Cross girder		ZD 4230	21.8	2.7	3.4	4,035
Cross girder		ZD 4230	21.8	1.5	4.4	4,707
Cross girder		ZD 463	25.1	3.8	4.5	7,904
1/2 Cross girder		ZD 463	11.2	2.3	4.4	3,649

Mechanisms

480 V - 60 Hz											hp	kW	
	<b>50 LVF 25 Optima</b>	fpm	131	171	249	331	66	85	125	164	50	37	912 ft
	USt	5.5	4.1	2.8	1.6	11	8.3	5.5	3.3				
	<b>50 LVF 25 GH Optima</b>	fpm	125	164	240	328	62	82	121	164	50	37	1,690 ft
	USt	5.5	4.1	2.8	1.5	11	8.3	5.5	3.2				
	<b>6 DVF 4 Optima</b>	fpm	0 → 262 (11 USt)				0 → 328 (2.2 USt)				5.5	4	
	<b>RVF 162 Optima+</b>	rpm					0 → 0.8				2 x 7.5	2 x 5.5	

480 V (+6% -10%) 60 Hz	50 LVF / 50 LVF GH: 58 → 38 kVA	

50 LVF 25 Optima

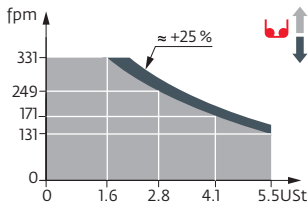

50 LVF 25 GH Optima

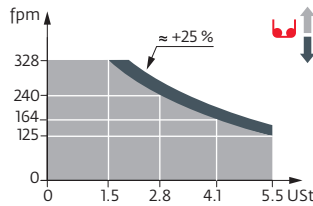

These mast combinations meet the EN 14439 and ASME B30.3-2016 specifications for "out of service" wind conditions, provided the illustrated wind speed matches required design wind speed for the location of the tower crane. The "out of service" design wind speed was determined in accordance with ASCE 7-10, Figure 26.5-1A. The wind velocity, used for this configuration was 98 mph (158 kph), which represents a nominal design 3-second wind gust at 33 ft (10 m) above ground for Exposure B category. A factor of 0.85 was applied to the 700-year ultimate design wind speed of 115 mph (185 kph), per ASCE 37-02, with the assumption that this crane is considered a temporary structure used during a construction period of 2 years or less.

- Jib elevation
- Standard equipment
- Options
- Potain Plus function: Plus load curves
- Hook heights with Plus load curves
- Reactions in service
- Reactions out of service
- Total ballast weight
- Jib weight
- Lorry 44 ft
- Container High Cube 40 ft, and/or Flat Rack 20 ft
- Hoisting
- Trolleying
- Slewing
- Travelling
- Required power
- Power Control Function: winch speeds adapted to the available power
- Consult us

This commercial document is not legally binding. For any technical information, please refer to the corresponding instructions.

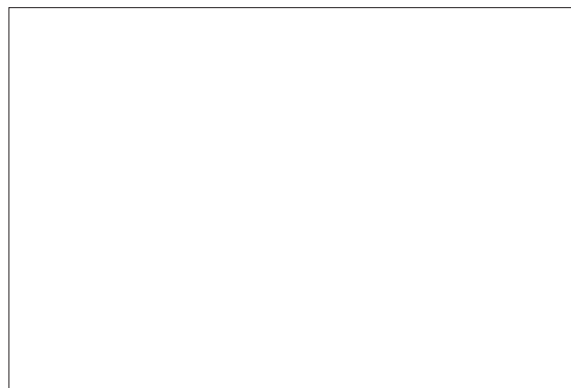

© 2021 The Manitowoc Company, Inc.  
www.manitowoc.com