

MDT 259 J10

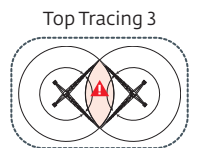

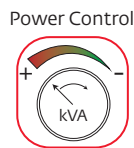

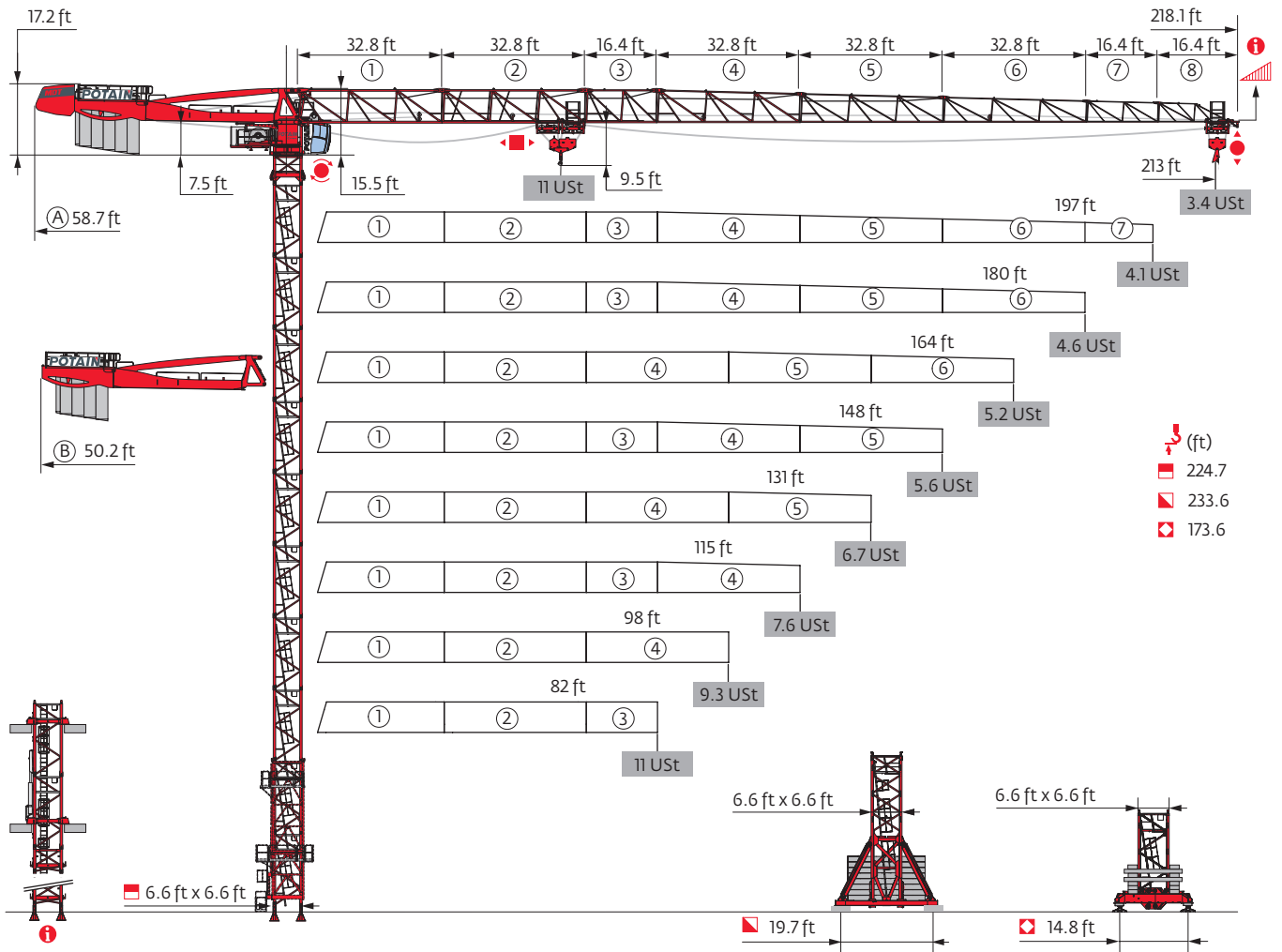

Mast - Reactions

6.6 ft - P 602B									
Height (ft)	82	98	115	131	148	164	180	197	213
Height (ft)	224.7	224.7	224.7	224.7	224.7	224.7	213.9	213.9	213.9
Height/P _r (ft)	224.7	224.7	224.7	224.7	224.7	224.7	213.9	213.9	213.9
6.6 ft	1	1	1	1	1	1	1	1	1
10.9 ft	2	2	2	2	2	2	1	1	1
16.4 ft	12	12	12	12	12	12	12	12	12
F2 (USt)	193	192	197	195	195	195	193	194	195
	329	328	334	331	338	339	307	306	313
F3 (USt)	142	140	143	140	139	139	136	136	137
	283	282	285	282	287	288	255	253	260

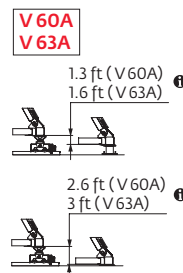
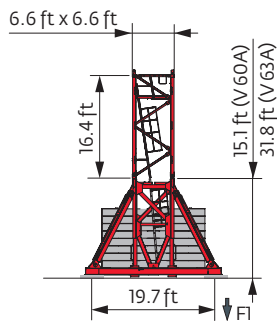
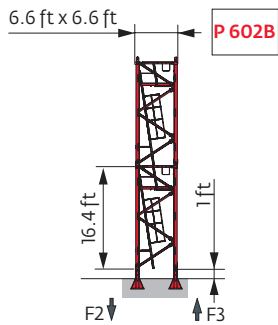
6.6 ft - V 60A -									
Height (ft)	82	98	115	131	148	164	180	197	213
Height (ft)	206	211.3	206	211.3	211.3	211.3	211.3	211.3	211.3
Height/P _r (ft)	206	211.3	206	211.3	211.3	211.3	211.3	211.3	211.3
6.6 ft	1	1	1	1	1	1	1	1	1
10.9 ft	2	1	2	1	1	1	1	1	1
16.4 ft	10	11	10	11	11	11	11	11	11
F1 (USt)	110	112	112	114	114	114	117	118	118
	145	151	147	152	156	157	155	154	158

6.6 ft - V 63A -									
Height (ft)	82	98	115	131	148	164	180	197	213
Height (ft)	228	233.6	233.6	233.6	233.6	233.6	233.6	228	228
Height/P _r (ft)	228	233.6	233.6	233.6	233.6	233.6	233.6	228	228
6.6 ft	1	1	1	1	1	1	1	1	1
10.9 ft	1	0	0	0	0	0	0	1	1
16.4 ft	11	12	12	12	12	12	12	11	11
F1 (USt)	131	133	134	134	135	135	138	134	134
	181	188	190	188	192	193	191	182	186



6.6 ft - ZD 463 - 									
WIND (ft)	82	98	115	131	148	164	180	197	213
 (ft)	168	173.6	168	168	168	168	168	162.7	162.7
 P+ (ft)	168	173.6	168	168	168	168	162.7	162.7	162.7
	6.6 ft	1	1	1	1	1	1	1	1
	10.9 ft	1	0	1	1	1	1	2	2
	16.4 ft	9	10	9	9	9	9	8	8
FI (USt)	● 111	114	113	111	110	112	116	115	115
	■ 130	138	133	129	134	135	133	124	129

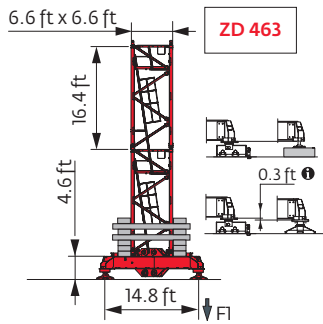

Note: When "ASCE" is noted in this data sheet it is referring to 115 mph Wind Zone, Exposure B, Design Wind Speed = 98 mph. See back cover for design wind speed calculations.

 Motorized accesses: adapted mast compositions, base ballast and reactions.

Anchorage



Base ballast

Ust) / 6.6 ft - V 60A -

ft)	82	98	115	131	148	164	180	197	213
211.3		145.5		145.5	145.5	145.5	145.5	145.5	145.5
206	145.5	145.5	145.5	132.3	145.5	145.5	132.3	132.3	132.3
189.6	105.8	105.8	105.8	105.8	105.8	105.8	105.8	105.8	105.8
173.2	79.4	79.4	79.4	79.4	79.4	79.4	92.6	92.6	92.6
156.8	66.1	66.1	66.1	66.1	66.1	66.1	66.1	66.1	66.1
140.4	52.9	52.9	52.9	52.9	52.9	52.9	52.9	52.9	52.9
124	39.7	39.7	39.7	39.7	39.7	39.7	39.7	39.7	39.7
107.6	39.7	39.7	39.7	39.7	39.7	26.5	26.5	26.5	26.5
91.2	39.7	39.7	39.7	39.7	39.7	26.5	26.5	26.5	26.5
74.8	39.7	39.7	39.7	39.7	39.7	26.5	26.5	26.5	26.5

Ust) / 6.6 ft - V 63A -

ft)	82	98	115	131	148	164	180	197	213
233.6		198.4	198.4	198.4	198.4	198.4	198.4		
228	198.4	185.2	185.2	185.2	185.2	185.2	185.2	185.2	185.2
211.6	158.7	158.7	158.7	145.5	158.7	158.7	145.5	145.5	145.5
195.2	132.3	119.1	119.1	119.1	119.1	119.1	119.1	105.8	119.1
178.8	92.6	92.6	92.6	92.6	92.6	92.6	92.6	92.6	92.6
162.4	79.4	79.4	79.4	66.1	66.1	66.1	79.4	79.4	79.4
146	66.1	66.1	66.1	52.9	52.9	52.9	66.1	66.1	66.1
129.6	52.9	52.9	52.9	39.7	39.7	39.7	52.9	52.9	52.9
113.2	39.7	39.7	39.7	39.7	26.5	26.5	39.7	39.7	26.5
96.8	26.5	39.7	26.5	39.7	26.5	26.5	26.5	26.5	26.5
80.4	26.5	39.7	26.5	39.7	26.5	26.5	26.5	26.5	26.5

Ust) / 6.6 ft - ZD 463 -

ft)	82	98	115	131	148	164	180	197	213
173.6		137.8							
168	132.3	126.8	132.3	126.8	121.3	126.8	137.8		
162.7	126.8	121.3	121.3	121.3	115.7	115.7	132.3	132.3	132.3
146.3	104.7	99.2	104.7	99.2	93.7	93.7	110.2	110.2	110.2
129.9	88.2	82.7	82.7	82.7	77.2	77.2	88.2	88.2	88.2
113.5	71.7	77.2	71.7	77.2	71.7	66.1	66.1	71.7	66.1
97.1	71.7	77.2	71.7	77.2	71.7	66.1	60.6	49.6	55.1
80.7	71.7	77.2	71.7	77.2	71.7	66.1	60.6	49.6	55.1
64.3	71.7	77.2	71.7	77.2	71.7	66.1	60.6	49.6	55.1

Load curves



		(ft)	66	72	82	89	98	105	115	121	131	138	148	154	164	171	180	187	197	203	213	ft
		11 Ust																				
		5.5 Ust																				
213	10 → 69	123 - 133	11	10.4	9	8.2	7.2	6.7	6	5.6	5.5	5.3	4.9	4.6	4.3	4.1	3.9	3.7	3.5	3.3	3.2	USt
	10 → 75	133 - 144	11	11	9.9	9	8	7.4	6.6	6.2	5.6	5.5	5.3	5.1	4.7	4.5	4.2	4	3.8	3.6	3.4	USt P+
197	10 → 73	130 - 141	11	11	9.6	8.8	7.7	7.2	6.4	6	5.5	5.5	5.2	5	4.6	4.4	4.1	4	3.7			USt
	10 → 79	141 - 152	11	11	10.6	9.7	8.5	7.9	7.1	6.6	6	5.7	5.5	5.4	5.1	4.8	4.5	4.3	4.1			USt P+
180	10 → 74	134 - 144	11	11	9.8	9	8	7.4	6.6	6.2	5.6	5.5	5.3	5.1	4.7	4.5	4.2					USt
	10 → 81	145 - 155	11	11	10.5	9.9	8.8	8.1	7.3	6.8	6.2	5.9	5.5	5.5	5.2	4.9	4.6					USt P+
164	10 → 74	134 - 144	11	11	9.9	9	8	7.4	6.7	6.2	5.7	5.5	5.4	5.1	4.7							USt
	10 → 81	145 - 156	11	11	10.9	9.9	8.8	8.2	7.3	6.9	6.2	5.9	5.5	5.5	5.2							USt P+
148	10 → 76	137 - 148	11	11	10.1	9.2	8.2	7.6	6.8	6.4	5.8	5.5	5.5									USt
	10 → 82		11	11	11	10.2	9	8.3	7.5	7	6.4	6	5.5									USt P+
131	10 → 79		11	11	10.5	9.6	8.5	7.9	7.1	6.7	6.1											USt
	10 → 85		11	11	11	10.6	9.4	8.7	7.8	7.3	6.7											USt P+
115	10 → 76		11	11	10.1	9.2	8.2	7.6	6.8													USt
	10 → 82		11	11	11	10.2	9	8.3	7.5													USt P+
98	10 → 78		11	11	10.3	9.5	8.4															USt
	10 → 84		11	11	11	10.4	9.2															USt P+
82	10 → 78		11	11	10.4																	USt
	10 → 82		11	11	10.9																	USt P+

$W = W - 0.53 \text{ USt max.}$



		(ft)	66	72	82	89	98	105	115	121	131	138	148	154	164	171	180	187	197	203	213	ft
		11 Ust																				
		5.5 Ust																				
213	8 → 69	124 - 127	11	10.5	9.1	8.3	7.3	6.8	6.1	5.7	5.3	5	4.6	4.3	4	3.8	3.5	3.4	3.2	3	2.85	USt
	8 → 75	134 - 137	11	11	10	9.1	8	7.4	6.7	6.2	5.7	5.3	5	4.8	4.4	4.2	3.9	3.7	3.5	3.3	3.1	USt P+
197	8 → 73	132 - 135	11	11	9.7	8.8	7.8	7.2	6.5	6.1	5.5	5.3	4.9	4.7	4.3	4.1	3.8	3.6	3.4			USt
	8 → 79	142 - 145	11	11	10.6	9.7	8.6	8	7.2	6.7	6.1	5.7	5.3	5.1	4.7	4.5	4.2	4	3.8			USt P+
180	8 → 75	135 - 138	11	11	9.9	9.1	8	7.5	6.7	6.3	5.7	5.5	5.1	4.8	4.5	4.3	4					USt
	8 → 81	146 - 149	11	11	10.6	10	8.8	8.2	7.4	6.9	6.3	5.9	5.5	5.2	4.9	4.7	4.4					USt P+
164	8 → 75	136 - 138	11	11	9.9	9.1	8.1	7.5	6.7	6.3	5.7	5.5	5.1	4.8	4.5							USt
	8 → 81	147 - 150	11	11	10.9	10	8.9	8.2	7.4	6.9	6.3	6	5.5	5.2	4.9							USt P+
148	8 → 76	139 - 141	11	11	10.2	9.3	8.3	7.7	6.9	6.5	5.9	5.5	5.2									USt
	8 → 83		11	11	11	10.3	9.1	8.4	7.6	7.1	6.5	6.1	5.6									USt P+
131	8 → 79		11	11	10.6	9.7	8.6	8	7.2	6.7	6.1											USt
	8 → 86		11	11	11	10.7	9.5	8.8	7.9	7.4	6.7											USt P+
115	8 → 76		11	11	10.2	9.3	8.2	7.6	6.9													USt
	8 → 83		11	11	11	10.2	9.1	8.4	7.6													USt P+
98	8 → 78		11	11	10.4	9.5	8.5															USt
	8 → 85		11	11	11	10.5	9.3															USt P+
82	8 → 79		11	11	10.5																	USt
	8 → 82		11	11	11																	USt P+

$W = W - 0.15 \text{ USt max.}$

Jib weight & counter-jib ballast



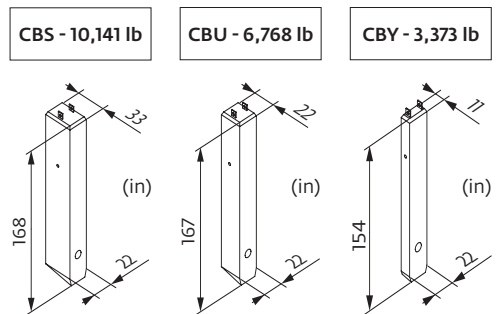

ft	CBS (lb) (+/- 5%)			CBS-10,141 lb		CBS-3,373 lb		CBS-6,768 lb		CBS-3,373 lb	
	Ust	Ust	Ust	10,141 lb	3,373 lb	6,768 lb	3,373 lb	6,768 lb	3,373 lb	6,768 lb	3,373 lb
213 ft	27,183	26,610	27,326	5	1	54,079	7	2	54,123		
197 ft	26,698	26,125	26,841	5	1	54,079	7	2	54,123		
180 ft	25,838	25,331	25,993	5	0	50,706	7	1	50,750		
164 ft	23,744	23,237	23,898	4	1	43,938	6	1	43,982		
148 ft	24,030	23,523	24,185	4	1	43,938	6	1	43,982		
131 ft	21,936	21,429	22,090	4	0	40,565	6	0	40,609		
115 ft	21,605	21,098	21,760	3	2	37,170	5	1	37,214		
98 ft	19,775	19,268	19,930	3	1	33,797	5	0	33,841		
82 ft	18,695	18,188	18,850	3	0	30,424	4	1	30,446		





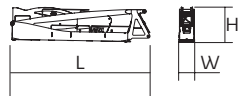

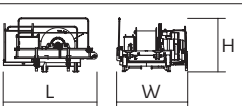
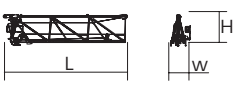
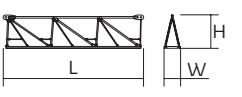
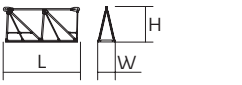
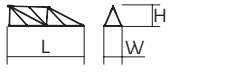

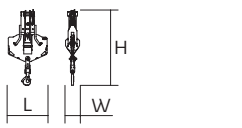
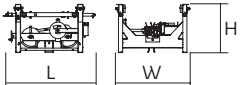
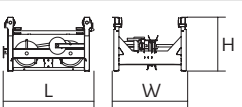
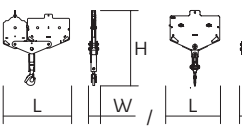

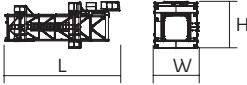
Dimensions and weight

Slewing crane part :  213 ft -  -  50 LVF

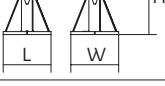

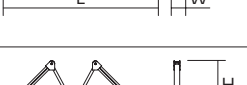
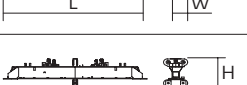
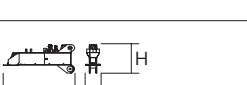
Slewing crane part		L (ft)	W (ft)	H (ft)	lb (+/- 5%)
Counter-jib		36.1 36.1	3.8 3.8	8.1 8.1	19,213 18,629
Towerhead + cab		16.1	7.5	8.3	18,618
Hoisting winch (+ rope)		10.6 10.6	8.1 10.8	6.2 5.8	7,319 9,092
Jib section		35.5	5.6	8.9	7,760
Jib section		33.8 33.5 33.6 33.4	3.9 3.9 3.9 3.9	7.9 7.8 6.9 6	5,335 3,439 2,723 1,753
Jib section		17.3 16.7	3.9 3.9	7.8 5	2,116 683
Jib section		16.7	3.9	4.6	485
Trolley		6.1	5	3.4	882
Pulley block		3.3	1.4	6.6	694
Trolley		5.2	5	3.2	463
Trolley		5.6 6.1	5 5	3.4 3.2	540 520
Pulley block		5.4 3.6	0.7 0.5	5.6 4.9	717 430

Crane tower		L (ft)	W (ft)	H (ft)	lb (+/- 5%)	
Telescopic cage T 61		□ 6.6 ft	35.5	13.6	14.7	21,385
K60/K60-2		□ 6.6 ft	7.3	8.2	8.1	4,255
K 649B KM 649E		□ 6.6 ft	33.6 33.8	6.8 6.7	6.7 6.7	11,663 10,692
K 649A KMT 649A KR 649A KRMT 649A		□ 6.6 ft	17.2 17.2 17.2 17.2	6.8 6.8 6.9 6.9	6.7 6.7 6.8 6.8	6,184 5,666 7,165 6,724
K 649C KMT 649C KRMT 649C		□ 6.6 ft	11.7 11.7 11.7	6.8 6.8 6.9	6.7 6.7 6.8	4,376 4,542 5,401
Fixing angles		P 602B	2.1	2.1	4.2	650
Basic mast unit		V 60A V 63A	16.4 32.9	7.9 7.9	7.9 7.9	9,674 16,502
Struts		V 60A V 63A	14.8 14.8	1 1.1	1 1.1	919 1,135
Half-bearer		V 60A V 63A	22 22	2.3 2.3	7.6 7.6	3,519 4,079
Cross girder		ZD 463	25.1	3.8	4.5	7,904
1/2 Cross girder		ZD 463	11.2	2.3	4.4	3,649

Mechanisms

480 V - 60 Hz											hp	kW			
	50 LVF 25 Optima	fpm	126	166	221	313	66	85	115	157	50	37	1,827 ft		
		USt	5.5	4.1	2.8	1.1	11	8.3	5.5	2.5					
	90 HPL™ 25	fpm	213	279	392	518	707	110	146	203	271	353	90	66	2,736 ft
		USt	5.5	4.1	2.8	1.4	0.4	11	8.3	5.5	2.8	1.3			
	6 DVF 4 Optima	fpm	0 → 164 (11 USt) 0 → 328 (6.6 USt) 0 → 394 (3.3 USt)									5.5	4		
	RVF 162 Optima+	rpm	0 → 0.9									2 x 7.5	2 x 5.5		

	IEC 60204-32		kVA
480 V (+6% -10%) 60 Hz		50 LVF: 58 → 38 kVA 90 HPL™: 90 → 54 kVA	

50 LVF 25 Optima

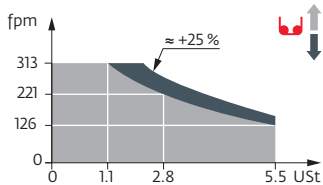

These mast combinations meet the EN 14439 and ASME B30.3-2016 specifications for “out of service” wind conditions, provided the illustrated wind speed matches required design wind speed for the location of the tower crane. The “out of service” design wind speed was determined in accordance with ASCE 7-10, Figure 26.5-1A. The wind velocity, used for this configuration was 98 mph (158 kph), which represents a nominal design 3-second wind gust at 33 ft (10 m) above ground for Exposure B category. A factor of 0.85 was applied to the 700-year ultimate design wind speed of 115 mph (185 kph), per ASCE 37-02, with the assumption that this crane is considered a temporary structure used during a construction period of 2 years or less.

- Jib elevation
- Standard equipment
- Options
- Potain Plus function: Plus load curves
- Hook heights with Plus load curves
- Reactions in service
- Reactions out of service
- Total ballast weight
- Jib weight
- Lorry 44 ft
- Container High Cube 40 ft, and/or Flat Rack 20 ft
- Hoisting
- Trolleying
- Slewing
- Travelling
- Required power
- Power Control Function: winch speeds adapted to the available power
- Consult us

This commercial document is not legally binding. For any technical information, please refer to the corresponding instructions.

